

# Outdoor Generator

## User Manual

### PORTABLE POWER STATION

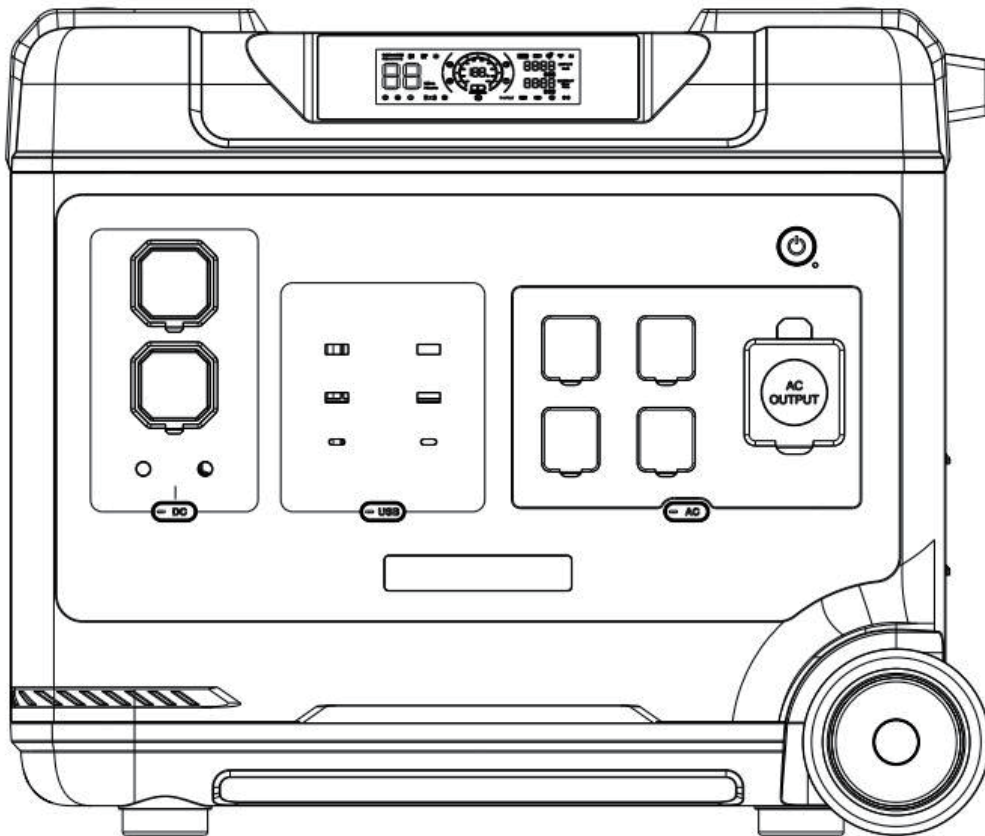

We deeply appreciate you for purchasing the P5000 Portable Energy Storage Power Supply. Be sure to read this book carefully before using the product to ensure you use it correctly. The book is required for product reimbursement. Consequently, it is advisable to keep it, alongside the invoice and other purchase certificates.

To guarantee the safety of this product during transportation, it is only about 30% charged when it is packed. As such, you are required to charge it immediately after opening and before use.

Please avoid the use of extension cords or cable taps, as this product can be charged directly from wall sockets etc. When using two or more sockets for charging, please avoid using any other products on the same socket.

# Content

|   |    |
|---|----|
| Disclaimers -----                       | 1  |
| Packing List -----                      | 2  |
| Specifications -----                    | 3  |
| Product Description -----               | 3  |
| Introduction to Display Interface ----- | 7  |
| UPS mode -----                          | 8  |
| Solar panel connection solution -----   | 9  |
| Onboard charging -----                  | 10 |
| Product Parameters -----                | 11 |
| Battery Specification -----             | 11 |
| FAQ -----                               | 12 |
| Maintenance -----                       | 14 |

## Disclaimers

Before using the product, please read the user manual carefully to ensure that you fully understand it before use. After reading, please keep the user's manual in a safe place for future reference. If you use this product incorrectly, you may cause serious injury to yourself or others, as well as product damage and property damage.

Once you use this product, you can be deemed to have understood, recognized and accepted all the terms of this manual. Users undertake responsibility for their own actions and all the consequences that may arise therefrom.

Our company does not assume any responsibility for any loss caused by users' failure to use the product in accordance with the User Guide. In order to comply with laws and regulations, the company has the final interpretation of this document and all related documents of this product.

# Packing List

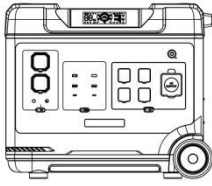

Portable Energy Storage  
Power Supply

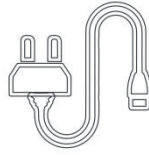

AC power cord



User Guide



XT60-MC4 Cable















XT60-Car Charger Cable

# Precautions for use

1. Please avoid high temperature and humidity. Please avoid using the product in direct sunlight and or near a fire.
2. Please be sure not to disassemble or modify the product, as it may cause malfunction or even a fire.
3. Please dispose off or recycle the product in accordance with the methods stipulated by local laws.
4. Be careful not to drop the product from a high place or expose it to any form of strong impact.
5. Please store or use the product out of the reach of children.
6. Please use the company's genuine products for the accessories. Customers who use non-genuine products and suffer adverse consequences as a result, cannot enjoy free maintenance.
7. When using this product, please do not interfere with the cooling of the product, please empty the ventilation space of more than 30CM from the side suction and exhaust port.
8. When the product is not in use, please put the body power off and unplug the power cord. Please avoid storing the product in a place with high temperature, high humidity and direct sunlight.
9. If you need to store the product for a long period of time, please make sure to deplete the charge once every 3 months, and then recharge it to about 50%.
10. If there is any doubt that the product body, the auxiliary line and the connecting equipment are defective, please do not continue to use the product. Instead, contact the after-sales personnel to solve the problem in time.
11. Please do not store the product for a long time in the car or field warehouse or other places that may experience extreme high and low temperature, to prevent the battery life from shortening amongst other failures.

## Specifications

|   |   |  |   |  |
|---|---|--|---|--|
| <br>Capacity | <br>Cycle life | <br>Weight      | <br>Size     | <br>RV(Aviation Port) |
| LiFePo4<br>51.2V  | ≥3500   | 51KG   | L550*W299*H487mm  | 24V/10A  |
| <br>USB-A*2  | <br>USB-A*2    | <br>TYPE-C*2    | <br>Output*2 | <br>Cigar Lighter*1   |
| 5V/2.4A   | QC3.0-18W   | PD-100W  | 12V/3A  | 12V/10A  |
| <br>AC       | <br>AC Input   | <br>PV/DC Input |   |  |
| 2200W<br>AC 100-120V<br>50/60Hz   | 1800W<br>100-120V 15A   | 12-120V/15A(MAX)<br>1000W (MAX)  |   |  |

## Product Description

This product is a portable energy storage power supply, suitable for home emergency power backup, outdoor travel, and emergency disasters that require power. In addition, it can also be used for outdoor work, amongst other applications.

This product has built-in lithium iron phosphate battery, which supports AC fast charging, vehicle charging, and solar photovoltaic panel charging. (This product has UPS function, and when the utility power fails, it can be switched on within 10ms for this product to supply power to electric equipment.)

The AC output of this product is pure sine wave waveform, and can manually be converted from 50HZ to 60HZ to provide better protection for electrical appliances.

This product comes with a telescopic dragging trolley bar, convenient for you to carry this product easily in.

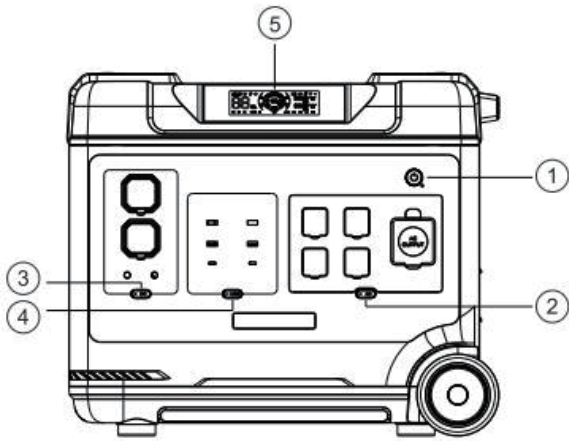

- ① Power switch
- ② AC switch
- ③ DC switch
- ④ USB switch
- ⑤ LCD screen

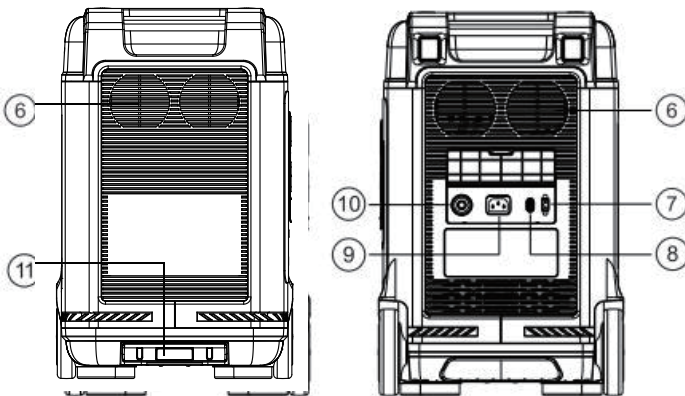

- ⑥ Air inlet/outlet
- ⑦ PV/DC input port
- ⑧ AC fast/slow charging switch
- ⑨ AC input port
- ⑩ Overload protector
- ⑪ Trolley extension/retraction button

## ① Power switch

How to use: Press and hold the power button for 3S to revive the system, turn on the LCD display, and press and hold it again for 3S to turn off the power system.

## ② AC switch

AC switch (AC output port \*5, the total electrical power load should be less than 2200W)

Note .

1. AC output voltage and frequency standards vary in different countries. Please check the AC voltage and frequency of the equipment before use.
2. Long press the AC button + POWER button for 3 seconds to achieve frequency switching.
3. By pressing the AC button 10 times in a row, the AC output voltage can be switched in 100V or 110V gears.



## ③ DC switch

Use: Short press the DC button to open the DC output port in the power-on state, and short press it again to close it.

|   |   |   |
|---|---|---|
|  |  |  |
| Output*2  | Cigar Lighter*1   | RV(Aviation Port)   |

#### ④USB switch

Usage: Short press the USB button to open the USB output port in the power-on state, and short press again to close it.

|   |   |   |
|---|---|---|
|  |  |  |
| USB-A*2   | USB-A*2   | TYPE-C*2  |
| 5V/2.4A   | QC3.0-18W   | PD-100W   |

#### ⑤LCD switch

Display the power and usage status of the product.

#### ⑥Cooling air inlet/outlet

The cooling fan will run automatically when the product reaches a certain temperature during use. Please avoid blocking the cooling air inlet/outlet and do not place objects within 30cm of the cooling air inlet/outlet during the use of the product.

#### ⑦PV/DC input port

The product can be charged by connecting the solar panel with the standard PV/DC port charging cable.

- 1.The input of the solar panel can be up to 1000W, with the maximum voltage being 120V.
2. If the PV/DC input port is charged with a voltage higher than 120V, the product will be damaged. A failure that is not covered by the warranty.

#### ⑧AC fast/slow charging switching switch

Toggle this switch to the corresponding gear, after which you will realize whether the AC port is on fast charging or slow charging mode.

When using the AC fast charging gear, you need to ensure that the output voltage of the power supply device meets 100-120V and the output current is greater than 15A.

1. The corresponding charging power is 1500W when the output voltage of the power supply device is 100V and the output current is greater than 15A.

2. The corresponding charging power is 1650W when the output voltage of power supply equipment is 110V and the output current is more than 15A.
3. The corresponding charging power is 1800W when the output voltage of power supply equipment is 120V and the output current is greater than 15A.
4. It is not recommended to use the voltage range beyond 100-120V to charge the product, because it may cause damage to the film, and this failure is not covered by the warranty.

## ⑨ AC charging port

After connecting the utility power to the AC charging port using the standard AC charging cable, you can charge this product.

Please ensure that the AC voltage and frequency of the device are consistent with the utility power before using the AC port for charging.

## ⑩ Overload protection button

In case of unstable power voltage supply due to lightning or other reasons, or if there is a large voltage input at the AC terminal, the overload protection function (safety circuit breaker) will be activated to protect this product and disconnect the AC input port from external devices.

Please restore the AC input function of this product in the following order.

1. Turn off the power button and unplug all ports.
2. After confirming that there is no abnormality in each part, turn on the power button.
3. Press the overload protection button and turn on the AC cable to resume AC input.

## ⑪ Pull rod extension/retraction button

Pressing this button enables the extension/shortening function of the pull rod.

# Introduction to Display Interface

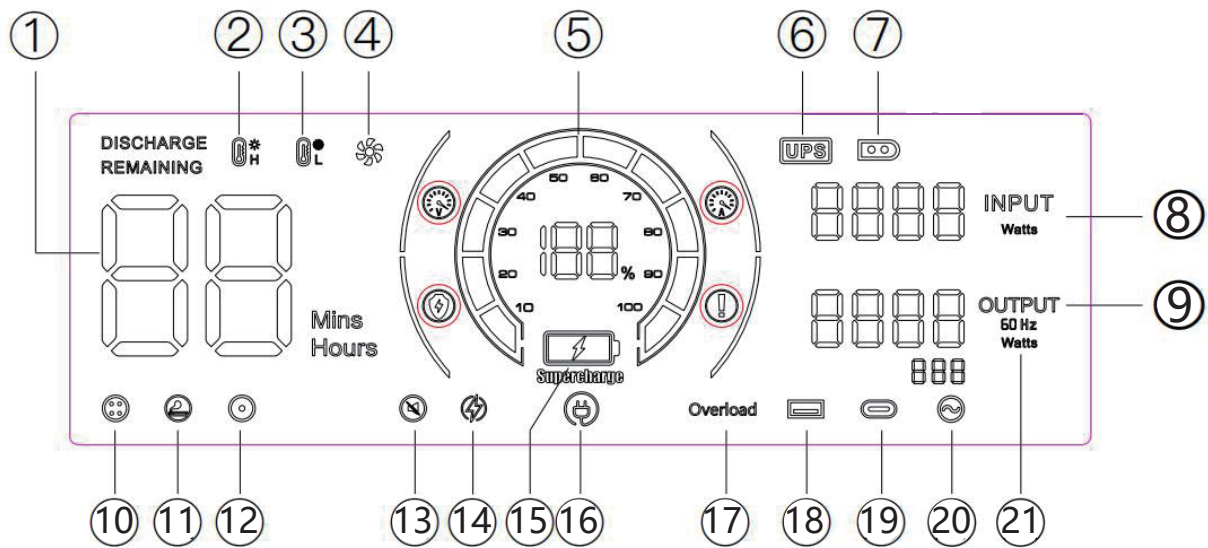

- |                              |                                  |                              |
|------------------------------|----------------------------------|------------------------------|
| ① Using time/charging time   | ② High temperature protection    | ③ Low temperature protection |
| ④ Fan status                 | ⑤ Power status                   | ⑥ UPS mode                   |
| ⑦ PV charging mode           | ⑧ Total input power              | ⑨ Total output power         |
| ⑩ Aerial socket (24V) output | ⑪ Cigarette lighter (12V) output | ⑫ DC(12V) output             |
| ⑬ Silent mode                | ⑭ Constant power mode            | ⑮ Fast charging mode         |
| ⑯ Slow charging mode         | ⑰ Overload protection            | ⑱ USB output                 |
| ⑲ PD output                  | ⑳ AC output                      | ㉑ Frequency Switching        |

## Note on screen display



When this icon is on, please ensure that the air inlet on both sides of the product is not blocked.



When the indicator icon flashes, it means that the internal temperature of the machine is too high or too low, at which time the device opens the intelligent protection program, forcing the machine to stop working normally. ( Wait for the machine to return to normal temperature, then you can start working again )



When the indicator icon is flashing, it means the utility input is abnormal, please check the charging end connection.



When this icon is flashing, it means the corresponding port output is abnormal, please check the load situation.



Press and hold the USB button for 2 seconds to enter silent mode.  
Double-click the AC button to enter constant power mode.

## UPS mode

The product has a bypass mode that can complete the output directly from AC power without the need to pass through the battery.

In UPS mode, when the city's AC input is suddenly interrupted, the product can automatically switch to battery power within 10ms, guaranteeing the normal operation of AC equipment..

### UPS connection diagram

As shown in the figure below, the product is connected between the socket and the electrical appliances, and the product's power is ON.

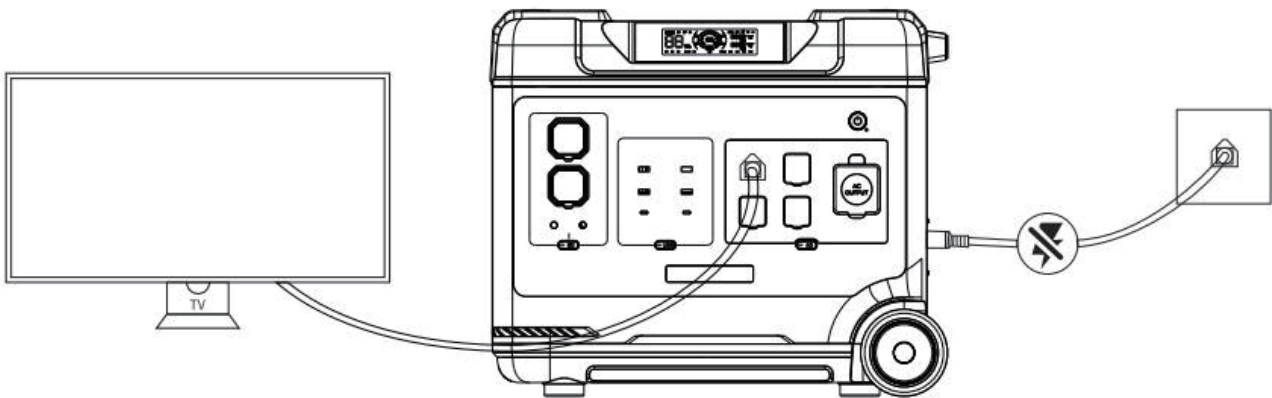

Once you turn on the electrical device, it makes use of grid AC power directly.

When the utility power is cut off while in this state, it will automatically switch to the product's internal battery power.

※ With the US standard, Japanese standard In UPS mode, if the maximum AC output power is less than 1400W and the AC output exceeds 1400W, the UPS icon blinks, indicating an overload and while the AC icon is off, the output is interrupted.

※ With the Chinese standard, British standard, European Standard, Korean standard In UPS mode, the maximum power output of AC is below 2000W. If the AC output exceeds 2000W, the UPS icon flashes to indicate overload, while the AC icon goes out and the output is interrupted.

# Solar panel connection solution

This product can both be connected to, and charged by the solar panel .

With a solar panel power of 1000W, and at least 5.2 hours, full charge can be achieved. (Solar panel charging maximum 1000W, maximum input voltage 120V)

※Solar panel charging power, with factors like the weather, climate and other conditions affecting the decision.

※Solar panel voltage over 120V will damage the device and may be out of warranty.

Solar panel connection scheme

## -Solar charging

Option 1

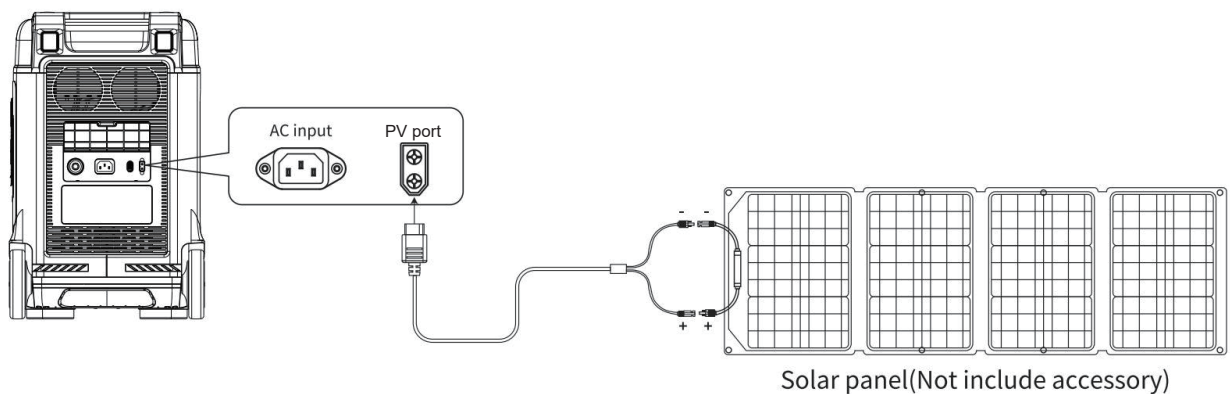

Option 2

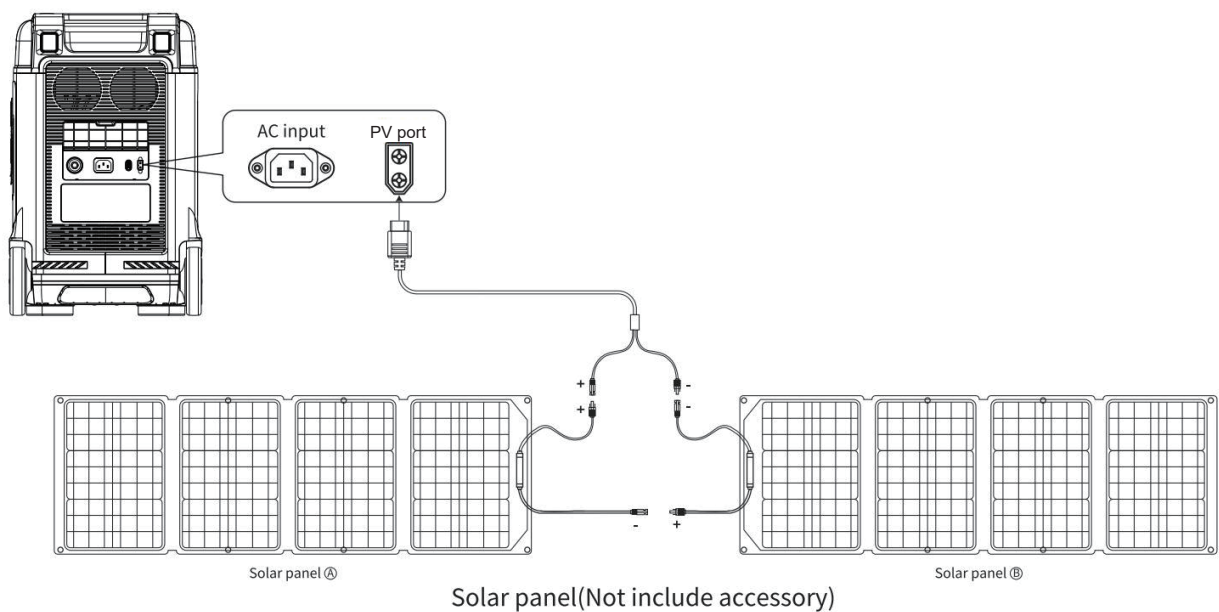

## Onboard charging

This product can be charged by the cigarette lighter (accessory: hereinafter referred to as ACC) in the car by using the ACC charging cable for mobile charging.

Turn the power of the product ON, connect the ACC charging cable to the cigarette lighter in the car and the Anderson connector on the side of the product, turn on the car engine, and the LED of the product will show the input power. The LED of this product will show the input power.

※Onboard charging ought to be done when the car engine is started. Failure to start the engine may cause the car's battery to run out of power.

※Onboard charging is usually low power of 90-240W and the charging time is long (12V/8A or 24V/10A). If fast charging is required, utility power is advised.

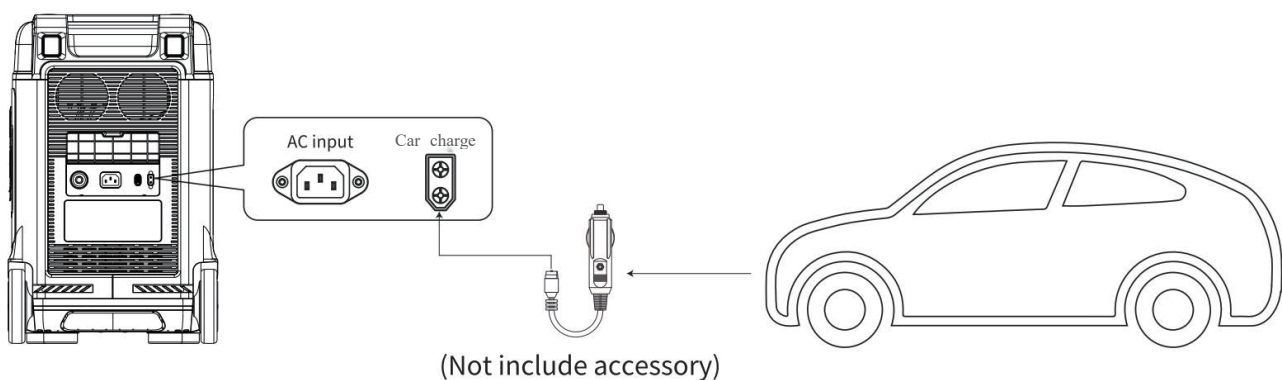

## Product Parameters

|                            |   |
|----------------------------|---|
| Product Name               | P5000 portable energy storage power supply  |
| Product size               | L550*W299*H487mm  |
| Product weight             | 51.0kg  |
| Battery Capacity           | 5120Wh  |
| AC charge                  | 100-120V/15A, 1800Wmax  |
| PV input                   | 12-120V/15A, 1000Wmax   |
| AC output                  | Rated 2200W, peak 4000W, 50/60HZ (switchable) pure sine wave, with overload, short circuit protection |
| USBQC3.0                   | (5-12V18W)x2  |
| USB                        | (5V2.4A)x2  |
| Type-C                     | 5-20V/5.0A, 100W max with PD3.0 protocol  |
| DC 5521                    | 12V/3A x 2  |
| Four-prong aviation socket | 24V/10A   |
| Car charger output         | 12V/10A   |
| Charging temperature       | 0~40°C  |
| Operating temperature      | -10~40°C  |
| Ambient humidity           | <90%RH  |
| Cycle charge               | >3500   |

## Battery Specification

|                                  |                        |
|----------------------------------|------------------------|
| Type                             | Lithium iron phosphate |
| Single battery rated voltage     | 3.2V                   |
| Rated capacity of single battery | 100Ah                  |
| Battery pack rated voltage       | 51.2V                  |
| Single cell weight               | 2KG                    |
| Rated capacity of battery pack   | 5120Wh                 |

## FAQ

1. The appliances power is within the rated output power range of the product but it cannot be used?

The power of the product is low and needs to be recharged.

When some electrical appliances are started, the peak power is higher than the product power, or the nominal power of the electrical appliance is greater than the product power;

2. Why is there a sound when using it?

The sound comes from the fan or the relay when you start or using the product.

3. Is it normal the charging cable heat up during use?

Yes, it is. The cable complies with national safety standards and has applied the certificates.

4. What kind of battery we use in this product?

The battery type is lithium iron phosphate.

5. What devices the product can support by the AC output?

The AC output is rated 2200W. It's available to power most of the home appliances, which rated power is lower than 2200W. Please make sure the total loading by AC is under 2200W. before using.

6. How can we know the remain using time?

Please check the data on the screen, it will show the remain using time when you turn on.

7. How can we confirm the product is recharging?

When the product is under charging, the product screen will show the input wattage, and the power percentage indicator will blink.

8. How should we clean the product?

Please use a dry, soft, clean cloth or tissue to wipe the product.

9. How to storage?

Please turn off the product and place it in a dry environment. Do not place this product near water.

For long-term storage, we recommend to use the product every three months(Run out the remain power first and recharge it to the percentage you want, such as 50%).

10. Can we take this product on airplane?

NO, you can't.

11. Is the actual output capacity of the product the same as the target capacity in the user manual?

The capacity of the user manual is the rated capacity of the battery pack of this product. Because this product has a certain efficiency loss during the charging and discharging process, the actual output capacity of the product is lower than the capacity specified in the user manual.

# Maintenance

1. It is recommended to use or store this product in an environment of 20°C to 30°C, away from water, heat, and other metal objects.
2. For safety reasons, please do not store this product in an environment higher than 45°C or lower than -10°C for a long time.
3. If it is not used for a long time, please charge it to 60% before storing. If the battery is left unused for a long time when the battery is seriously insufficient, it will cause irreversible damage to the battery and shorten the cycle life of the product.

 Web:[www.acopower.com](http://www.acopower.com)

 Email:[Sales@ACOPower.com](mailto:Sales@ACOPower.com)

 Phone: +1 (626) 575-7722

 Address: 4120 Valley Blvd, Walnut, CA 91789, USA